

N

News

IL FANALE



N

News

IL FANALE

CONTENTS

I PRODOTTI

A ALMA
Matteo Cibic
pg 10

B BLOOM
Matteo Zorzenoni
pg 34

L'AZIENDA

IL FANALE
pg 02

DESIGNERS
pg 06

NEW FINISHES
pg 58

T TYPHA
Calvi Brambilla
pg 16

A ARMADA
Brogliato Traverso
pg 40

P PLIÉ
Paolo Dell'Elce
pg 22

M MAJORETTE
Matteo Bianchi
pg 46

B BAGAN
Sara Moroni
pg 28

T TO-BE
Il Fanale
pg 52

News
2019

IL FANALE

Le lampade Il Fanale sono opere "di arte e di luce", in grado di inserirsi in contesti contemporanei configurandosi come richiami all'inconfondibile tradizione stilistica italiana. La produzione, interamente locale, è in grado di fondere alla perfezione un sublime artigianato con le più recenti tecnologie d'illuminazione dando vita così a prodotti unici e senza tempo. I materiali utilizzati per la realizzazione di tutte le lampade Il Fanale, sono quelli più rappresentativi della tradizione: ottone, rame, ferro.

Il Fanale lamps are works "of art and light" that can enter the contemporary contexts as references to the Italian tradition. The production, being entirely Italian, is able to join to perfection sublime handicrafts with the latest illumination techniques thus giving life to unique and timeless products. The materials used for the production of all Il Fanale lamps, are those most representative of the tradition: brass, copper, iron.

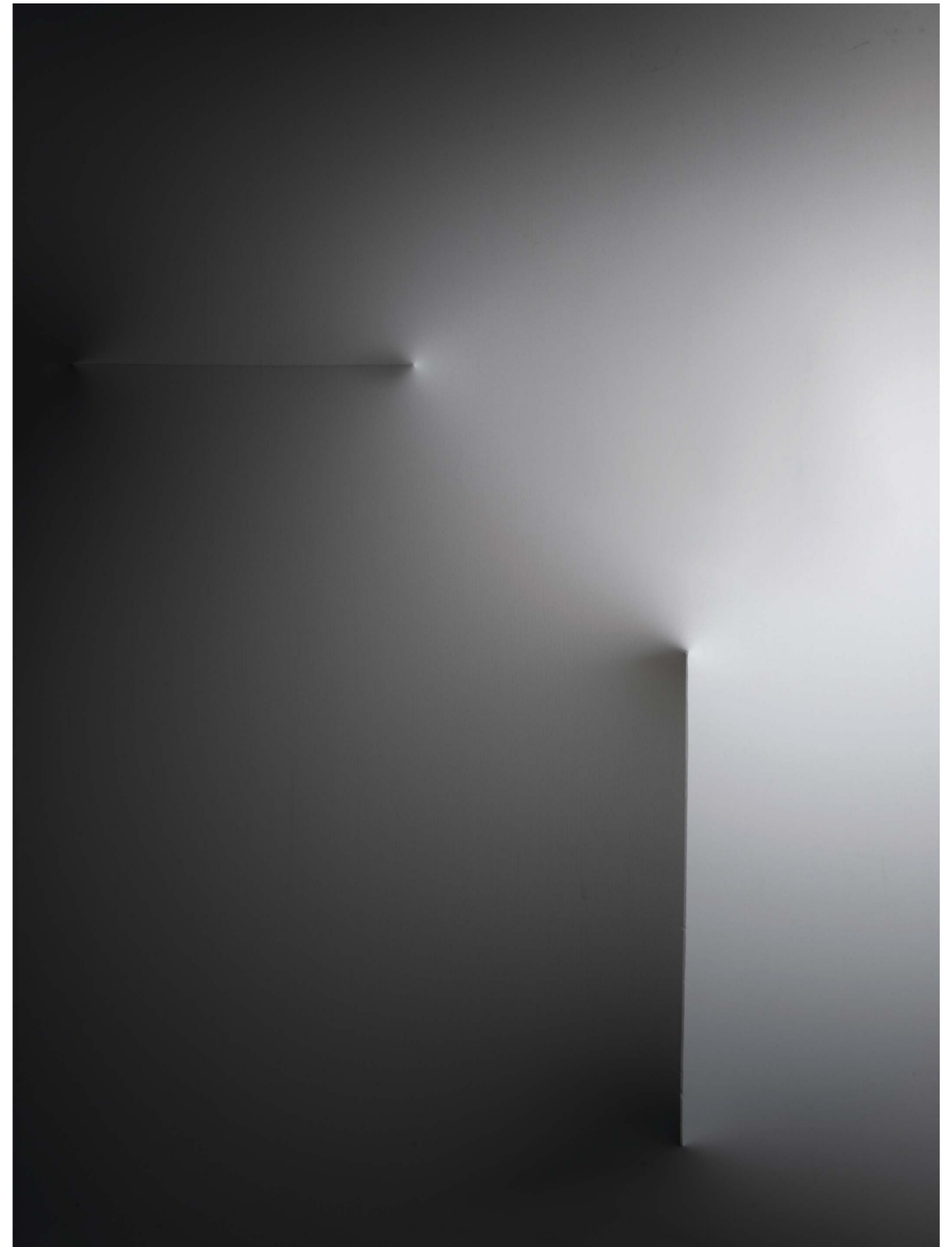



Il Fanale esprime la propria identità di brand attraverso quattro diverse linee, ciascuna rappresentativa di uno stile e al tempo stesso dell'evoluzione del brand nel tempo per allinearsi ai trend e ai mercati internazionali.

Il Country richiama volutamente un gusto decorativo legato al passato, di cui recupera forme e colori ma è in realtà uno stile molto attuale per decorare qualsiasi ambiente e renderlo caldo, raffinato e accogliente. L'Industrial dove tratti sono essenziali, i toni scuri e sfumati e le forme creano continuità con lo spazio circostante. L'aspetto chiave è la finitura invecchiata, capace di conferire un carattere metropolitano e dinamico. La collezione Modern significa linee pulite in cui l'aspetto estetico non è mai slegato dalla componente funzionale. Richiami alla visione minimalista delle forme e degli spazi si fondono con un approccio più morbido nell'uso dei colori e delle forme che giocano con le proporzioni per rappresentare la nostra contemporaneità. La collezione New Decò, infine, è la rivisitazione dei tratti caratterizzanti dell'opulento stile Art Decò, nato in America negli anni 20, che ancora oggi è fonte d'ispirazione per il design contemporaneo che ne riprende il gusto ma ne alleggerisce i tratti. Materiali a specchio come il cromo, tonalità oro e argento, cipria e grigio con una nota color melanzana. E la simmetria che è fondamentale in questo stile ricco ed energetico che conferisce fascino e prestigio agli spazi.

Il Fanale expresses its brand identity through four different lines, each representing a style and at the same time the evolution of the brand over time to align with international trends and markets. The Country style with its shapes and colours, intentionally recalls a decorative taste from the past, but in reality it is a very contemporary style that embellishes any space, making it warm, refined and inviting.

In the Industrial style lines are essential, the shades are dark and subtle and the shapes give a sense of continuity with the surrounding space. But the key feature is the aged finishing that gives a metropolitan and dynamic look.

Modern means clean lines where the aesthetic aspect is never disconnected from the functional element. References to the minimalistic vision of forms and spaces merge with a softer approach in the use of colours and shapes that play with proportions to portray our contemporaneity. The New Decò is a reinterpretation of the characterising features of the opulent Art Deco style, born in the USA in the 1920s and still a source of inspiration for contemporary designers who have revived the taste but made it lighter. Mirror-like materials like chrome, gold and silver tones, powder and grey with a hint of aubergine colour. And the symmetry, essential in this rich and energetic style, which lends charm and prestige to spaces.

DESIGNERS



Brogliato Traverso



Calvi Brambilla



Matteo Cibic



Paolo Dell'Elce



Matteo Bianchi



Sara Moroni



Matteo Zorzenoni

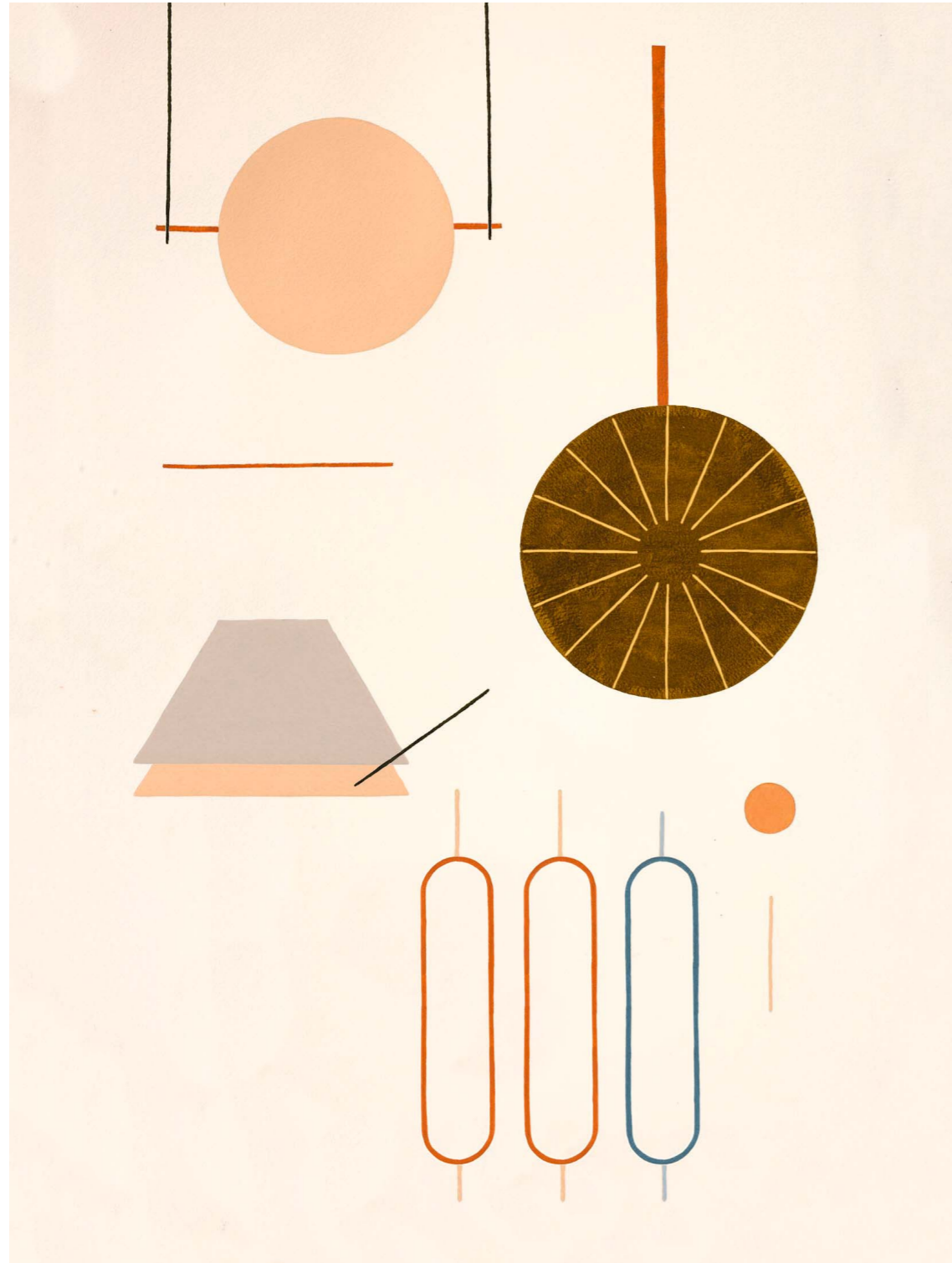

NEWS 2019

Prodotti caratterizzati da elementi decorativi più marcati di chiara ispirazione retrò ed altri più essenziali dove l'animo funzionale e tecnico combaciano grazie all'uso della tecnologia a LED. Con queste nuove collezioni, Il Fanale continua il suo percorso nella cultura dei materiali nobili, che rappresenta l'identità del marchio ma al tempo stesso conferma il passaggio stilistico che completa il progetto iniziato dall'azienda con l'inserimento dell'art déco e dell'industrial. La luce è l'elemento fluido e giocoso plasmato dalle mani dei designer. Ciascuno di essi ha rielaborato a proprio modo l'animo del marchio che per il suo quarantesimo compleanno si regala un nuovo look, contemporaneo, internazionale ed eclettico come le personalità dei suoi interpreti.

Products characterized by a very decorative taste with a visible retro inspiration and others more essential where the functional and technical sides match thanks to the use of LED technology. With these new collections, Il Fanale continues its path in the culture of noble materials, which represents the identity of the brand but at the same time confirms the stylistic transition that completes the project started by the company with the inclusion of the art deco and industrial style. Light is the fluid and playful element shaped by the hands of the designers. Each of them has re-elaborated in its own way the spirit of the brand that celebrates 40 years with a new look, contemporary, international and eclectic as the personalities of its interpreters.

Matteo
Cibic

ALMA

Suggestiva fusione di vetro e ottone, ALMA si inserisce con discrezione in ambienti contemporanei lasciando un segno di luce intenso dato dalla fonte luminosa a led dimmerabile. La geometria bilanciata conferisce un senso di stabilità alleggerito dalle sfere luminose sospese. Il risultato finale è un oggetto iconico con un'aura immateriale. ALMA è disponibile con finitura ottone spazzolato o nero in 5 modelli a sospensione.

A suggestive fusion of glass and brass, ALMA fits discreetly into contemporary settings, with intense light given off by the dimmable LED light source. The balanced geometry gives a sense of stability lightened by the suspended light spheres. The result is an iconic object with an immaterial aura. ALMA is available in 5 pendant models with a brushed brass or black finish.

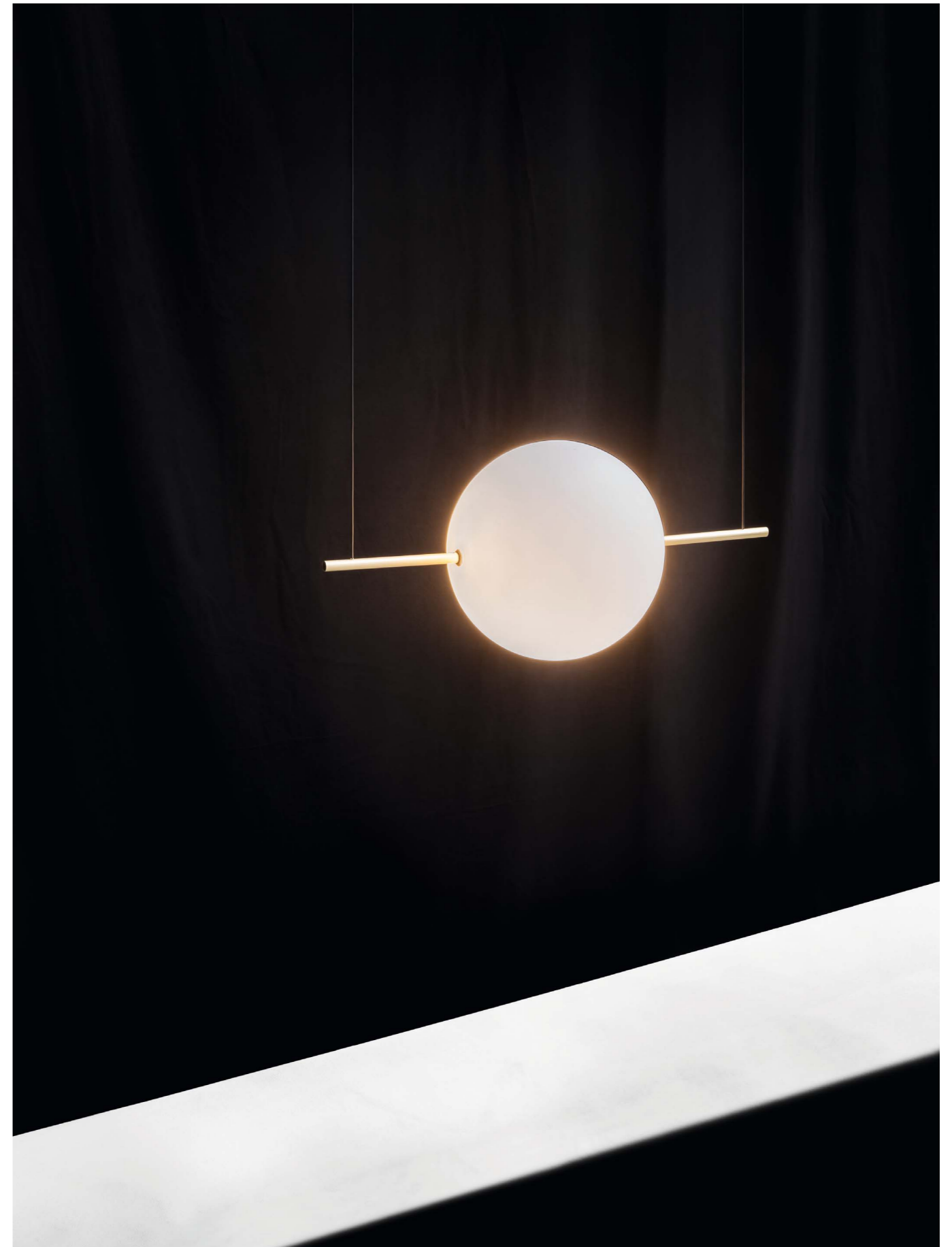

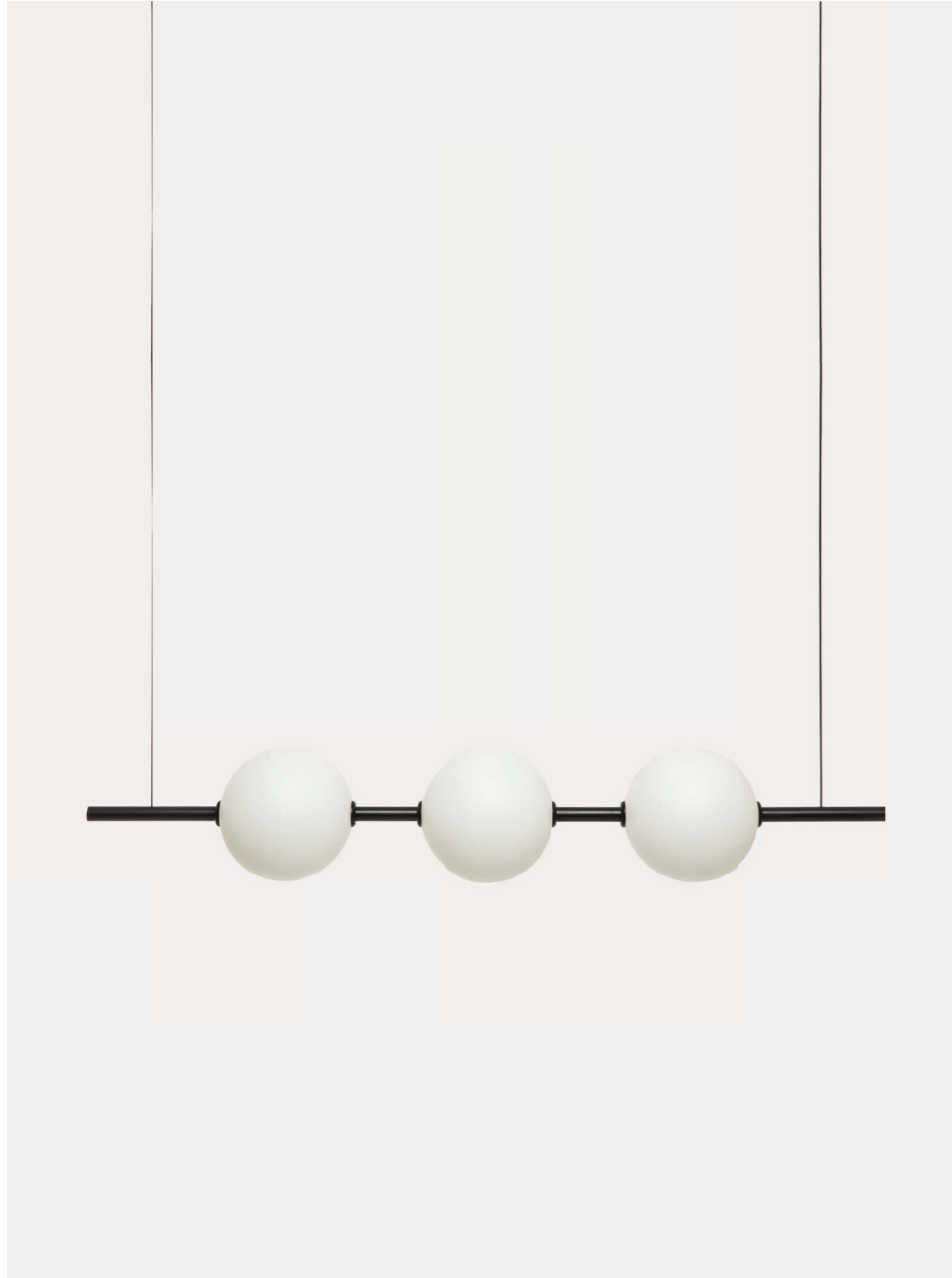

Alma — 282.03.NN



Alma — 282.02.ON

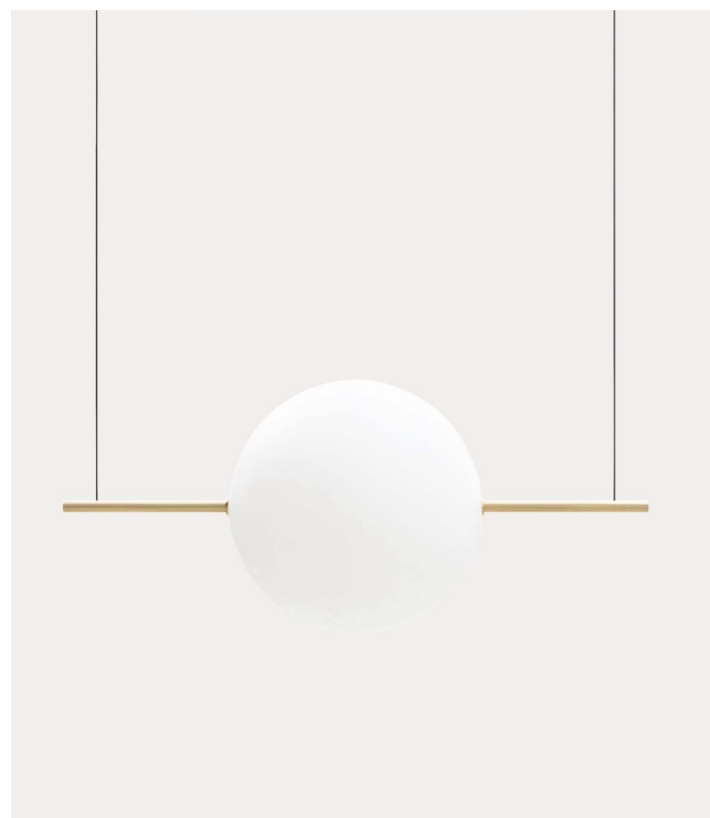

Alma — 282.04.ON

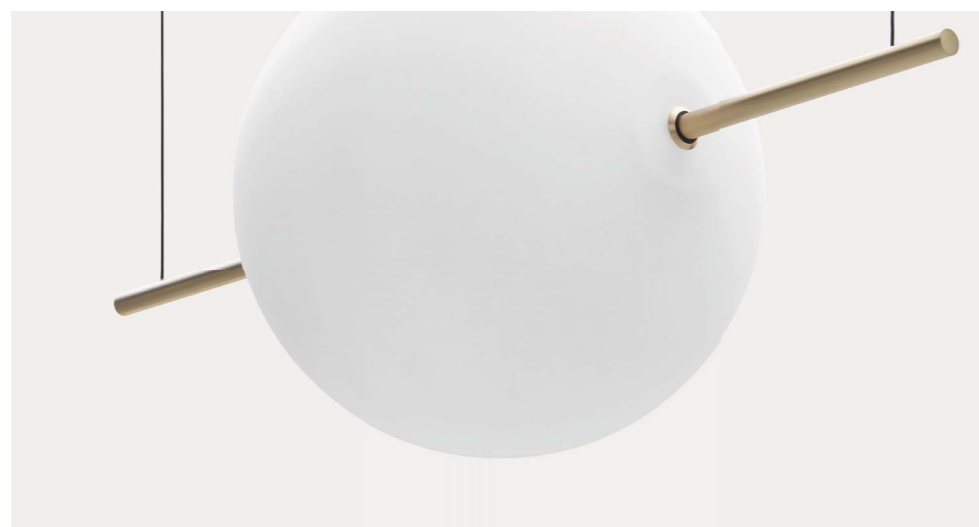

Alma — 282.01.ON

ALMA

Matteo
Cibic

FINITURE / FINISHES

ottone naturale
natural brass
ON

nero
black
NN

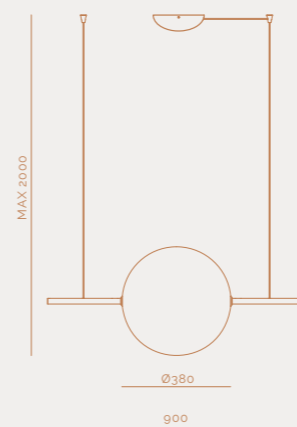

282.01.ON
282.01.NN

1 x 17W LED

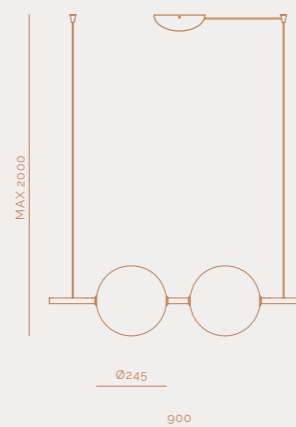

282.02.ON
282.02.NN

1 x 19W LED

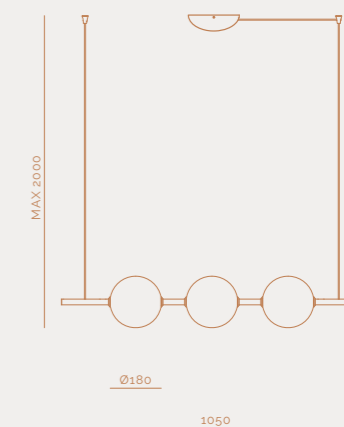

282.03.ON
282.03.NN

1 X 20W LED

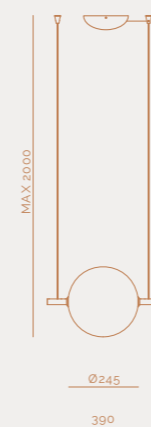

282.04.ON
282.04.NN

1 x 10W LED



282.05.ON
282.05.NN

1 x 7W LED

Calvi
Brambilla

TYPHA

La forma del modulo luminoso è quella della Typha Latifolia, nome botanico della bellissima pianta acquatica a forma di spiga. Ogni gambo in ottone sboccia in una luce a LED racchiusa da un vetro tubolare. A seconda dell'effetto che si vuole ottenere e dello spazio da decorare è possibile scegliere tra sospensioni a una, tre o sei luci, il modello a parete o la piantana a tre luci.

The shape of the light module is inspired by the Typha latifolia, the botanical name of this beautiful spiky water plant. Each brass stem blooms in a LED light enclosed by tubular glass. Depending on the desired effect and the space to decorate, it is possible to choose from pendant lamps with one, three or six lights, the wall lamp or the floor lamp with three lights.





Typha — 285.02.ON



Typha — 285.01.ON

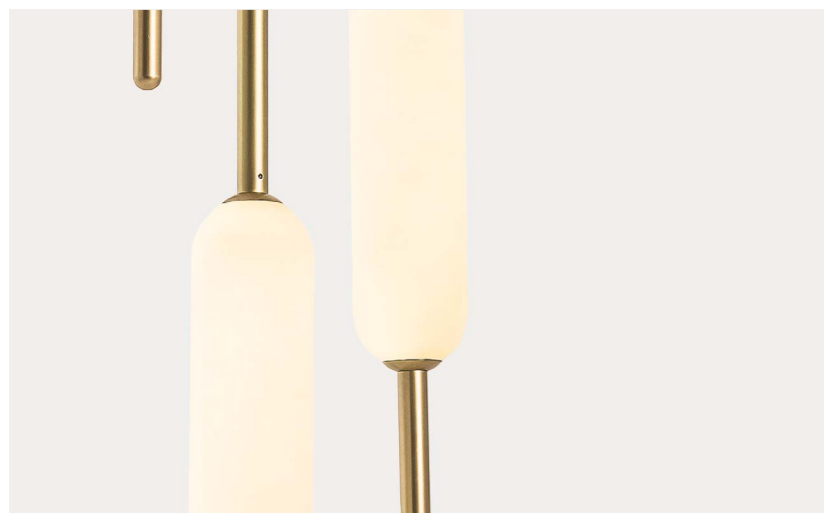

TYPHA

Calvi
Brambilla

FINITURE / FINISHES

 ottone naturale
natural brass
ON

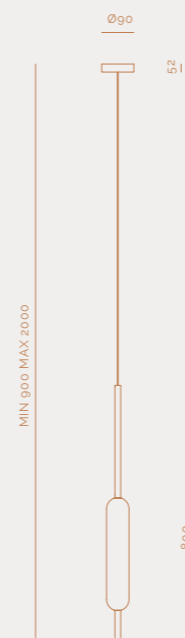

285.01.ON
1 x 10W LED

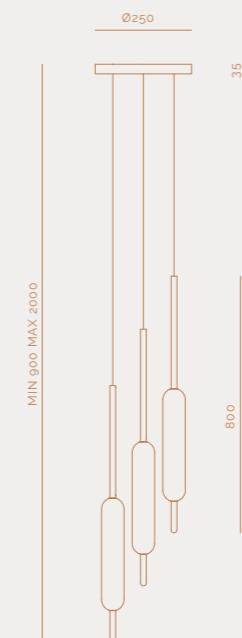

285.02.ON
3 x 10W LED

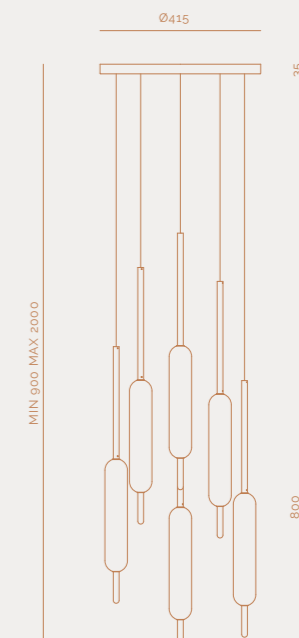

285.03.ON
6 x 10W LED

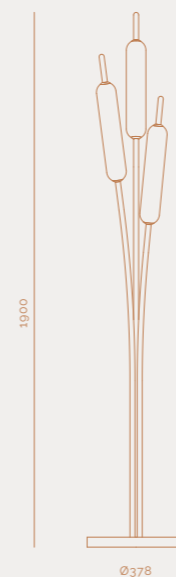

285.04.ON
3 x 10W LED



285.05.ON
1 x 10W LED



Paolo
Dell'Elce

PLIÉ

Il progetto consiste nella reinterpretazione in chiave moderna del tradizionale diffusore conico in ceramica con effetto "plissettato". Questo elemento iconico è stato rivisitato prevedendo l'uso di ottone lucidato o alluminio nero e integrando una sorgente LED nel corpo del diffusore. Il risultato è un oggetto compatto dall'aspetto romantico, utilizzabile singolarmente o in serie, che ricorda la gonna a ruota negli eleganti abiti femminili anni 50.

The project consists of a modern reinterpretation of the traditional conical ceramic diffuser with a "pleated" effect. This iconic element has been reinterpreted using polished brass or black aluminum and adding a LED source into the diffuser. The result is a compact object with a romantic look that can be used as a single piece or in combination and that recalls the elegant pleated skirts of 1950s female fashion.



Plié — 284.06.NN



Plié — 284.01.ON



Plié — 284.01.ON

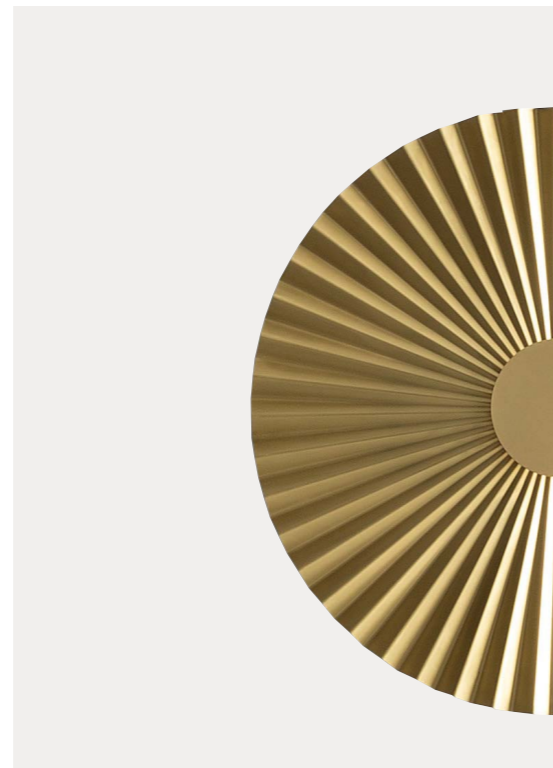

Plié — 284.05.ON

PLIÉ

Paolo
Dell'Elce

FINITURE / FINISHES

ottone naturale
natural brass
ON

nero
black
NN

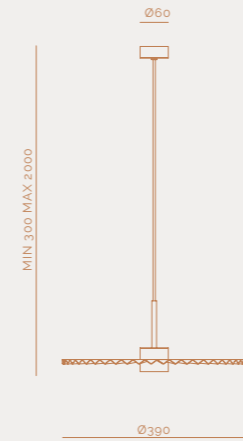

284.01.ON
284.01.NN
1 x 8W LED

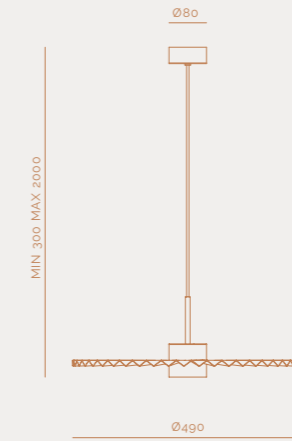

284.02.ON
284.02.NN
1 x 10W LED

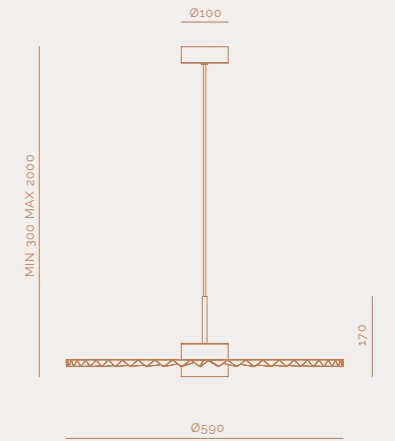

284.03.ON
284.03.NN
1 x 12W LED

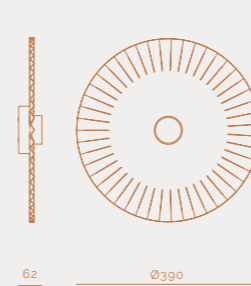

284.04.ON
284.04.NN
1 x 8W LED

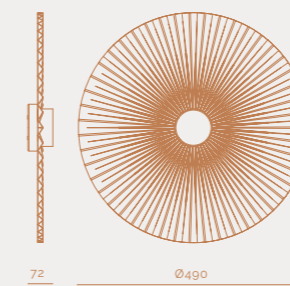

284.05.ON
284.05.NN
1 x 10W LED

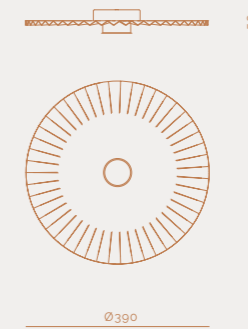

284.06.ON
284.06.NN
1 x 8W LED

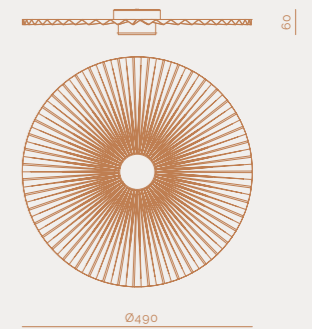

284.07.ON
284.07.NN
1 x 10W LED

Sara
Moroni

BAGAN

BAGAN è una reinterpretazione del tradizionale "saliscendi".

Il risultato del processo creativo è una collezione in ottone caratterizzata da un elegante contrappeso che consente di muovere su e giù la luce secondo necessità. Immaginando i possibili scenari luminosi e applicativi è nata una linea "cinetica" e flessibile dal linguaggio stilistico iconico e contemporaneo dal fascino retrò. Versatile, ricercata nelle finiture, installabile singolarmente o in composizioni multiple BAGAN diventa un sistema capace di adattarsi a vari contesti del vivere quotidiano.

BAGAN is a reinterpretation of the traditional "up and down" light.

The result of the creative process is a collection in brass featuring an elegant counterweight that allows to move the light up and down at will. This flexible, "kinetic" collection with its iconic style and retro charm was conceived by imagining the various style lighting and functional lighting scenarios. Versatile and refined in its finishes, BAGAN can be installed individually or in multiple compositions and become a system adaptable to the different contexts of everyday living.





Bagan — 281.03.ON



Bagan — 281.02.ON



Bagan — 281.01.ON

BAGAN

Sara
Moroni

FINITURE / FINISHES

 ottone naturale
natural brass
ON



281.01.ON
1 x 5W LED

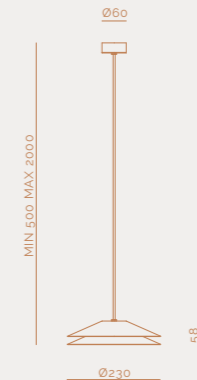

281.02.ON
1 x 5W LED

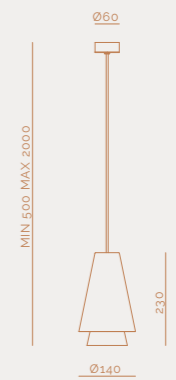

281.03.ON
1 x 5W LED



281.04.ON
1 x 5W LED



281.05.ON
1 x 5W LED

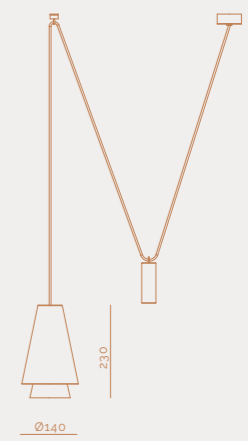

281.06.ON
1 x 5W LED

Matteo
Zorzenoni

BLOOM

BLOOM ricorda la preziosità delle bottiglie di profumo antiche e la forma dei diffusori orientali di essenze. A seconda del vetro e della fonte luminosa prescelta, l'effetto può essere più ovattato o sensuale. La magia dell'oggetto si sprigiona sia dal pezzo singolo che dalla combinazioni di più varianti. La linea si compone di lampade a sospensione e da tavolo disponibili sia con luce a LED che alogena. Il vetro è color rosa o grigio con lavorazione Balloton anche in versione satinata.

BLOOM calls to mind the preciousness of the old perfume bottles and the shape of oriental essence diffuser. According to type of glass and the lighting source, the effect can be more delicate or sensual. The object releases its magic both by a single piece or in a combination of elements. The range consists of pendant and table lamps available with LED or halogen light. The Balloton glass is pink or grey also available with frosted finishing.





Bloom — 279.04.GS / 279.04.P



Bloom — 279.02.PS



Bloom — 279.03.PS



Bloom — 279.02.G



Bloom — 279.01.G



Bloom — 279.04.PS

BLOOM

Matteo
Zorzenoni

FINITURE / FINISHES

- ottone naturale
natural brass
- ON**
- vetro grigio
grey glass
- G**
- vetro rosa
pink glass
- P**

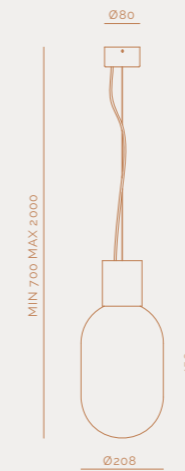

- | | |
|-----------|-----------------|
| 279.01.G | 1 X MAX 77W E27 |
| 279.01.GS | 1 X MAX 77W E27 |
| 279.11.G | 1 x 10W LED |
| 279.11.GS | 1 x 10W LED |
| 279.01.P | 1 X MAX 77W E27 |
| 279.01.PS | 1 X MAX 77W E27 |
| 279.11.P | 1 x 10W LED |
| 279.11.P | 1 x 10W LED |

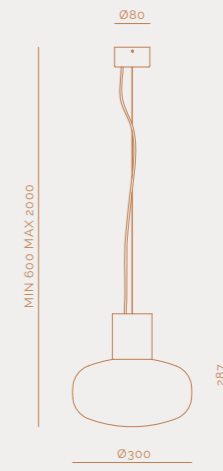

- | | |
|-----------|-----------------|
| 279.02.G | 1 X MAX 77W E27 |
| 279.02.GS | 1 X MAX 77W E27 |
| 279.12.G | 1 x 10W LED |
| 279.12.GS | 1 x 10W LED |
| 279.02.P | 1 X MAX 77W E27 |
| 279.02.PS | 1 X MAX 77W E27 |
| 279.12.P | 1 x 10W LED |
| 279.12.PS | 1 x 10W LED |



- | | |
|-----------|-----------------|
| 279.03.G | 1 X MAX 77W E27 |
| 279.03.GS | 1 X MAX 77W E27 |
| 279.13.G | 1 x 10W LED |
| 279.13.GS | 1 x 10W LED |
| 279.03.P | 1 X MAX 77W E27 |
| 279.03.PS | 1 X MAX 77W E27 |
| 279.13.P | 1 x 10W LED |
| 279.13.PS | 1 x 10W LED |

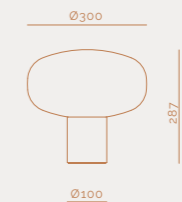

- | | |
|-----------|-----------------|
| 279.04.G | 1 X MAX 77W E27 |
| 279.04.GS | 1 X MAX 77W E27 |
| 279.14.G | 1 x 10W LED |
| 279.14.GS | 1 x 10W LED |
| 279.04.P | 1 X MAX 77W E27 |
| 279.04.PS | 1 X MAX 77W E27 |
| 279.14.P | 1 x 10W LED |
| 279.14.PS | 1 x 10W LED |



Brogliato
Traverso

ARMADA

Ispirata alle armature per il cemento armato, ARMADA con il suo groviglio visivo restituisce un senso di profondità interessante, con un rapporto tra vuoti e pieni tutto da scoprire. La ricerca di un equilibrio formale tra le maglie metalliche genera volumi che sembrano nascere da segni retti tracciati nello spazio. L'anima decorativa si unisce a quella funzionale. A luce spenta, è un oggetto d'arredo con una personalità forte ma versatile. A luce accesa, il telaio di metallo saldato che abbraccia il fascio di luce, riesce a creare un effetto luce-ombra e un'atmosfera affascinante.

Inspired by the rebar for the concrete, ARMADA visual tangle gives an exciting sense of depth, with its interplay of solid and voids. The search for a formal balance of the metal mesh generates volumes that seem to come from right signs traced in space. The decorative soul is combined with the functional one. When the light is switched off, it is a piece of furniture with a strong but adaptable personality. As soon as you turn on the light, the welded frame embracing the light creates playful shadows and a very cool atmosphere.

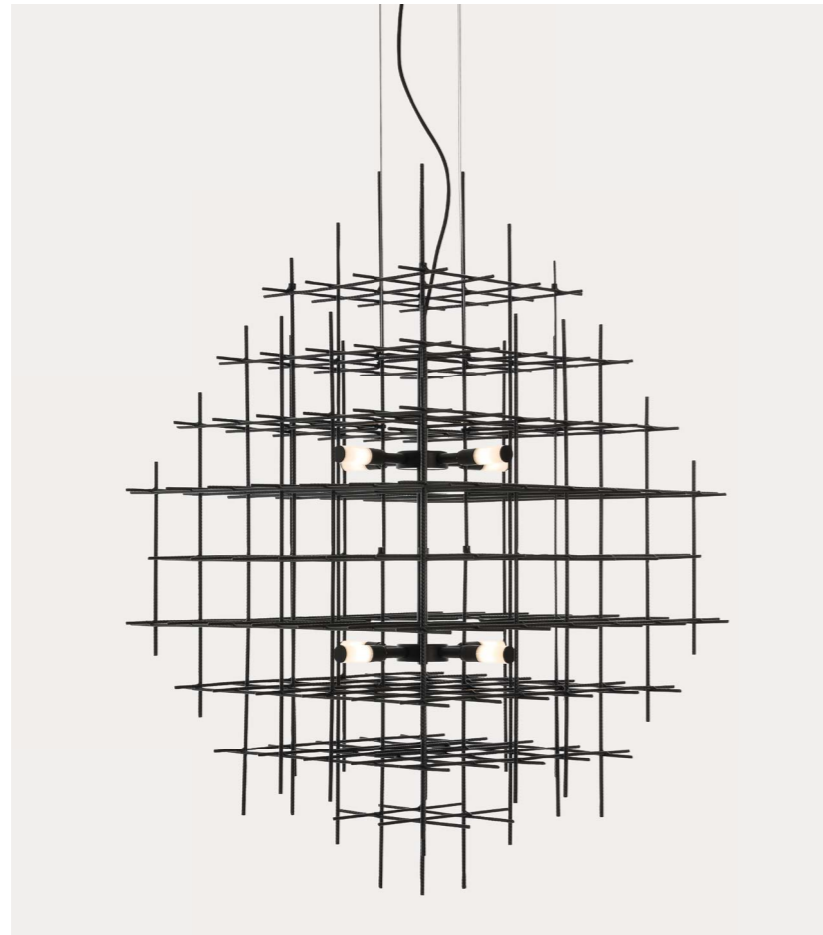

Armada — 283.03.NN

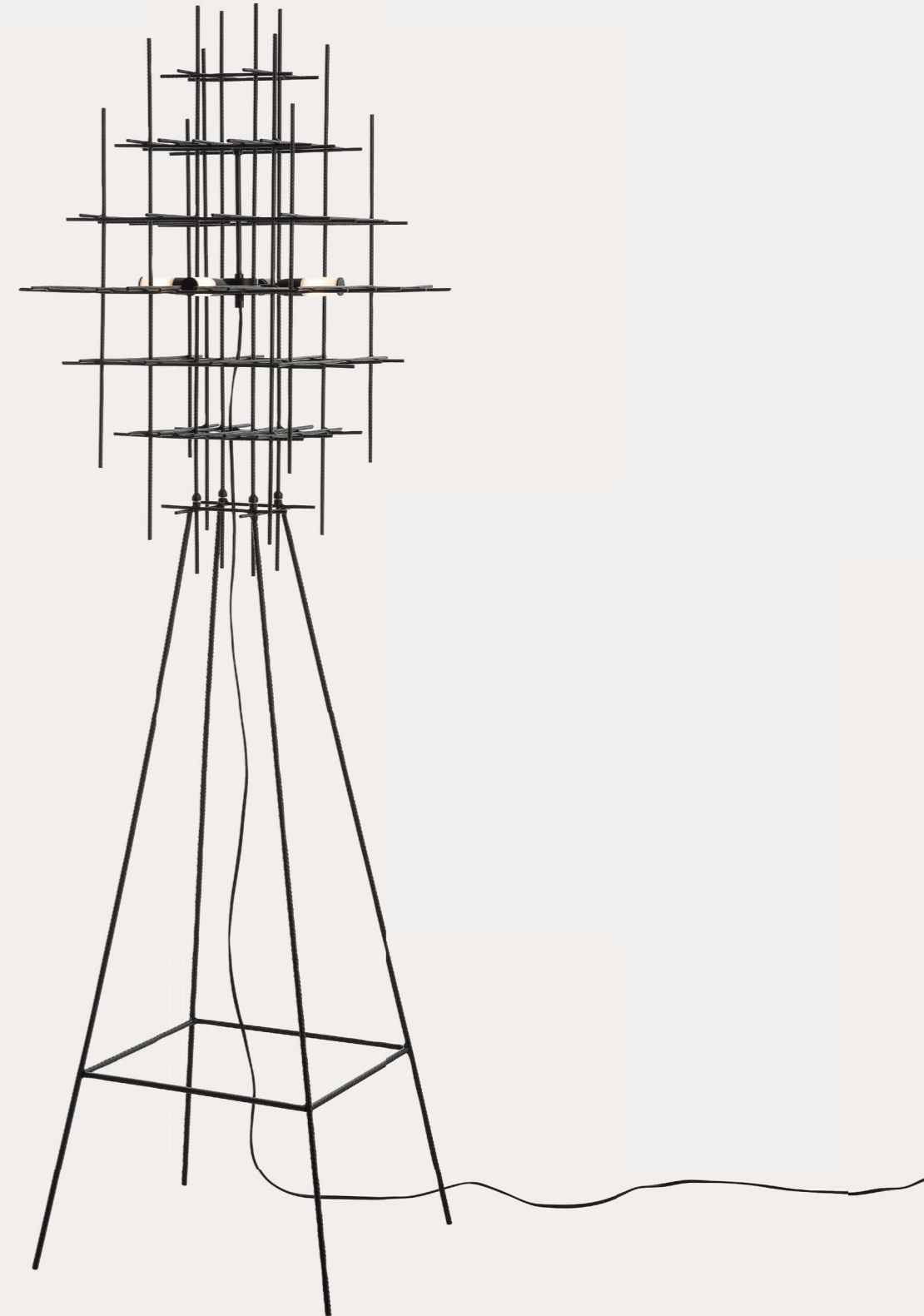

Armada — 283.04.NN

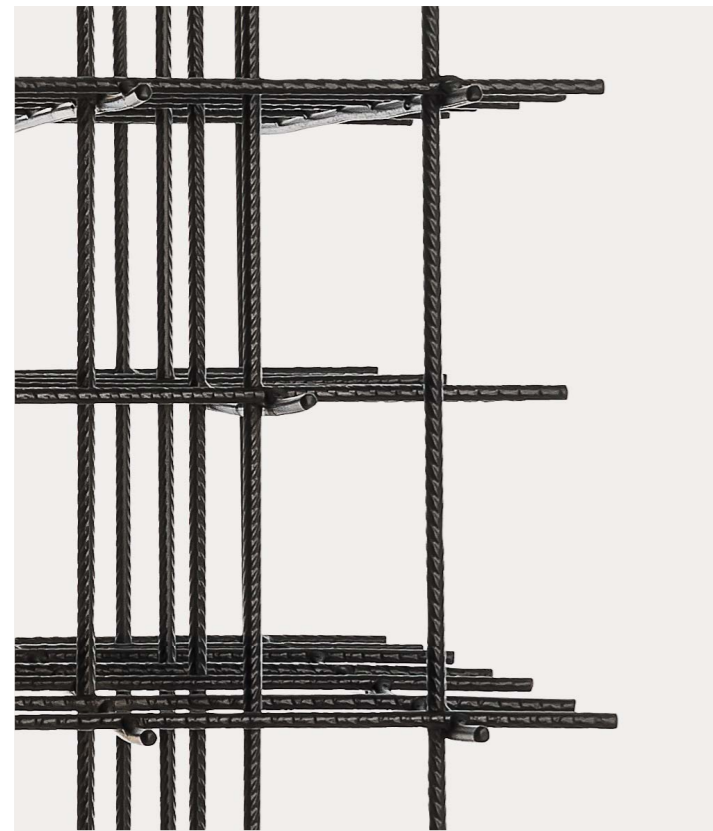
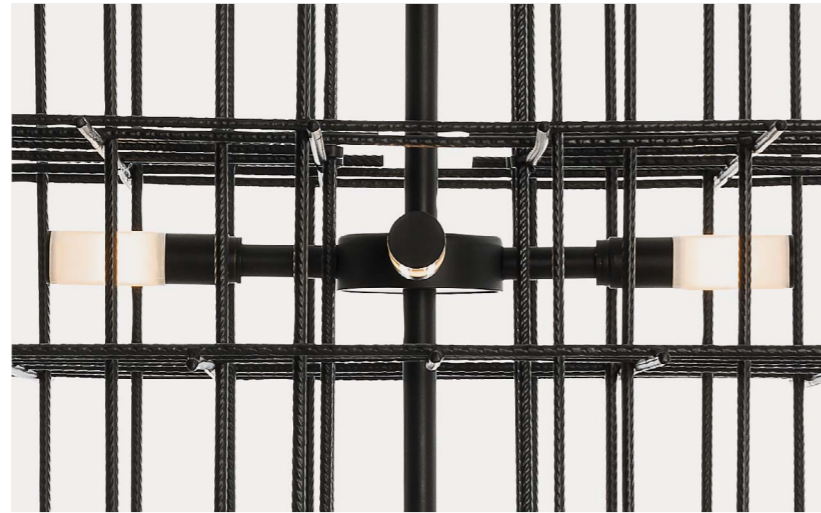

ARMADA

Brogliato
Traverso

FINITURE / FINISHES

● nero
● black
● NN

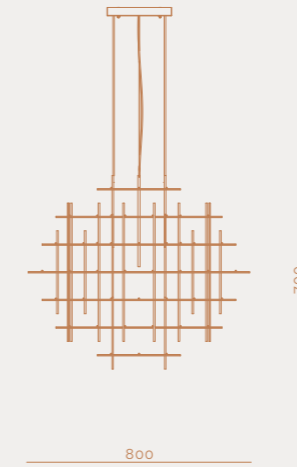

283.02.NN
5 X MAX 25W G9

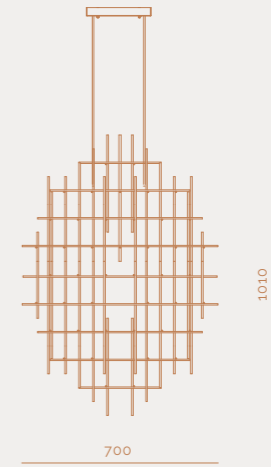

283.03.NN
8 X MAX 25W G9

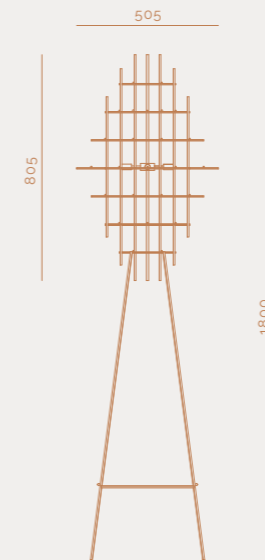

283.04.NN
4 X MAX 25W G9

Matteo
Bianchi

MAJORETTE

Una luce lineare, decorativa ma non troppo invasiva che illumina in maniera uniforme spazi di aggregazione come banchi, isole e tavoli e rispondendo così ad una specifica esigenza del mercato. La collezione esibisce la sua anima ludica offrendo la possibilità di giocare con la sua versatilità e la sua forma leggera che ricorda il bastone delle majorette o i fili su cui camminano gli acrobati circensi. Disponibile in due versioni a sospensione e un modello a parete.

With its decorative but not overly invasive linear shape, this light uniformly illuminates meeting spaces like desks, workstations and tables, responding to specific market needs. The collection exhibits its playful identity allowing to play with its slight and versatile shape that recalls a majorette's stick or the wires on which circus acrobats perform. Available in two pendant models and one wall model.



Majorette

Matteo Bianchi

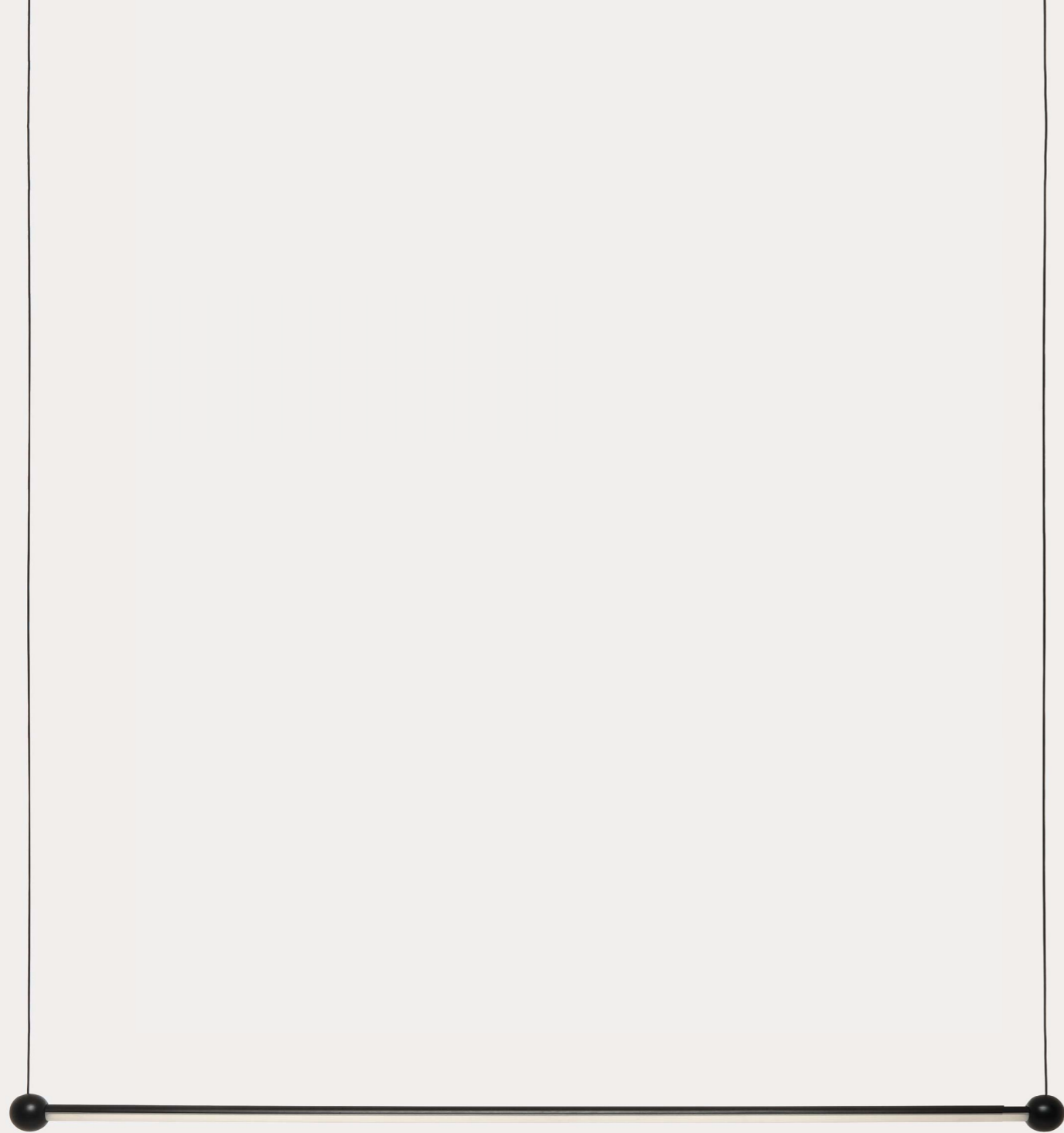

Majorette — 278.01.NN



Majorette — 278.01.NN



MAJORETTE

Matteo
Bianchi

FINITURE / FINISHES

● nero
black
NN

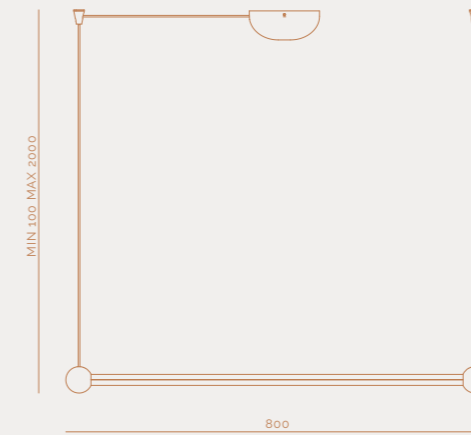

278.01.NN
1 x 15W LED

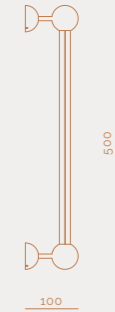

278.03.NN
1 x 10W LED

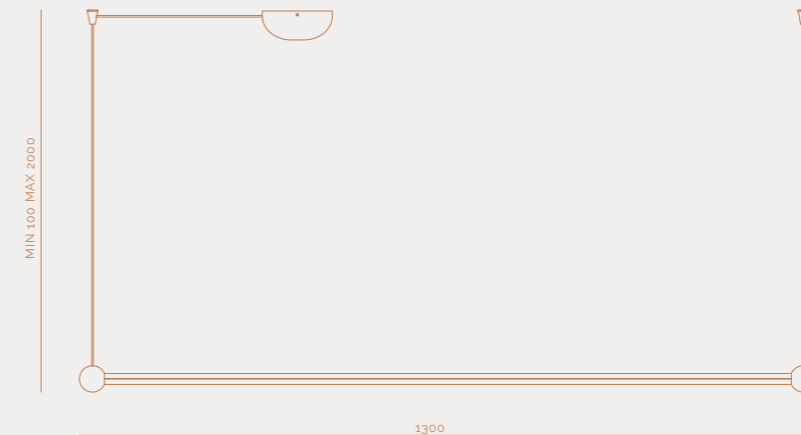

278.02.NN
1 x 25W LED

Il Fanale

TO-BE

La nuova collezione da esterno TO-BE rappresenta la risposta tecnico decorativa all'esigenza di utilizzare oggetti piccoli per l'outdoor. Si tratta infatti di quattro modelli di tubetti di diametro 30cm e di altezza 25 o 40 cm. L'acciaio e la fonte luminosa a LED rendono TO-BE un prodotto con una forte valenza tecnica mentre le diverse inclinazioni consentono di modulare il fascio luminoso nel contesto. La semplicità della forma e le dimensioni non intaccano la forte personalità.

The new TO-BE collection represents the decorative technical response to the need to use small objects for the outdoors. The collection is composed by four models of tubes with diameter of 30 cm and high of 25 cm or 40 cm. The use of steel and the LED light source make TO-BE a product with a strong technical value, while the different inclinations and measures allow the light beam to be modulated in the context. The simplicity of the form does not affect the strong personality.

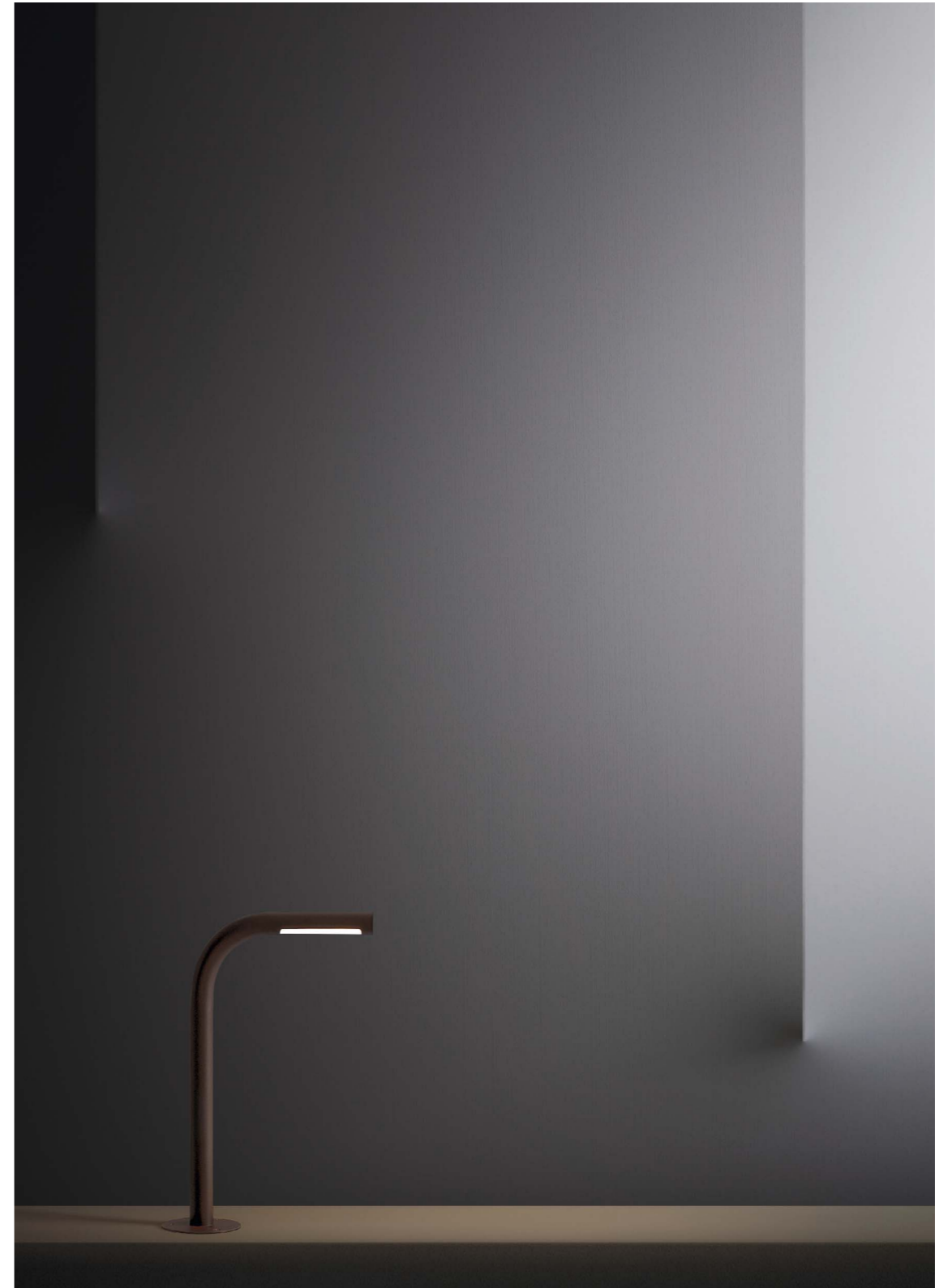



To-be — 280.06.44



To-be — 280.04.44



To-be — 280.08.44



To-be — 280.01.44



TO-BE

Il Fanale

FINITURE / FINISHES

● marrone
brown

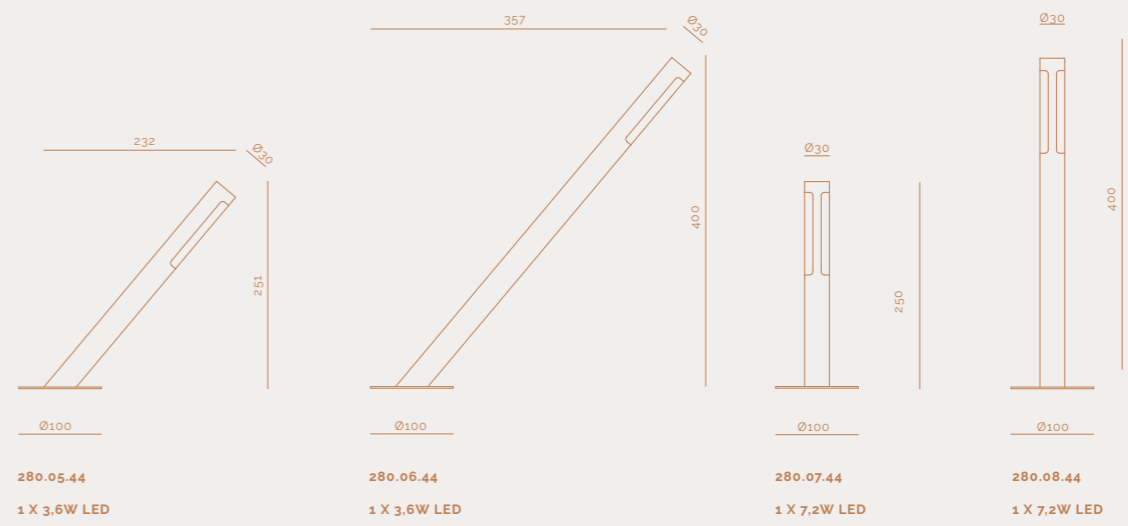
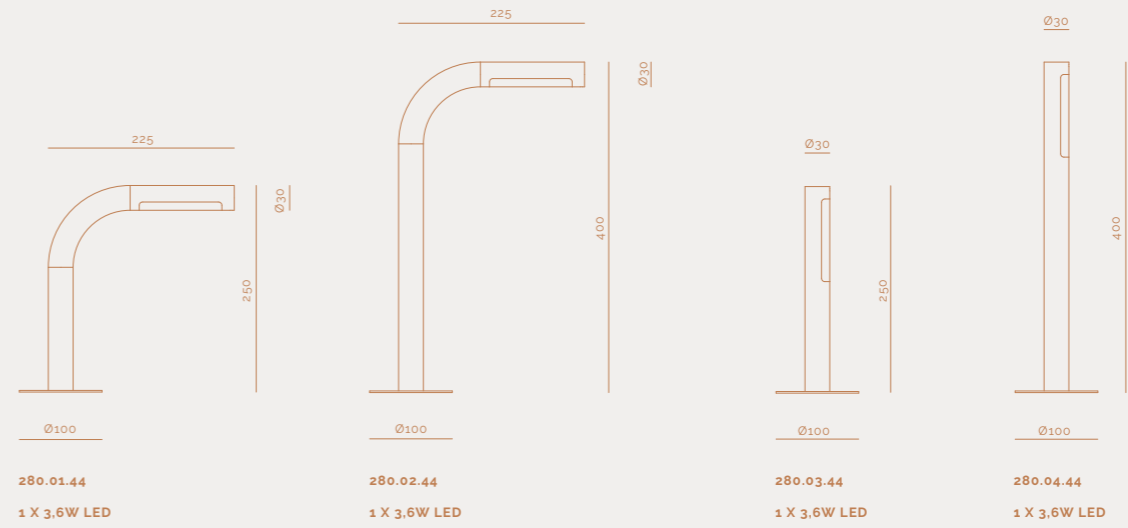

MOLECOLA

Fabrizio
Fava

FINITURE / FINISHES

 vetro ramato
coppery glass
R
new

 nero
black
NN
new



Molecola — 275.13.NNR

NEW FINISHES

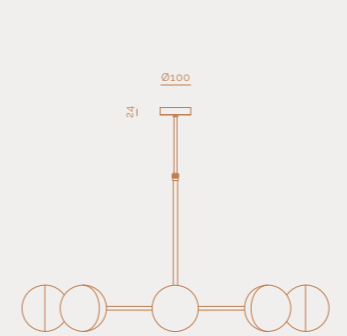

275.08.NNR

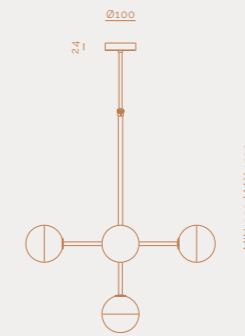

275.09.NNR

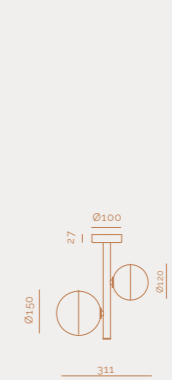

275.04.NNR

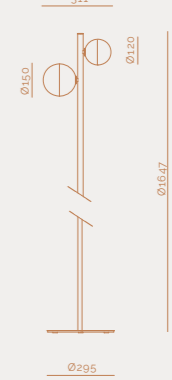

275.11.NNR

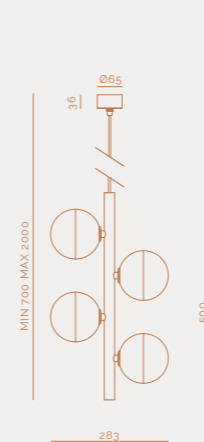

275.13.NNR

new product

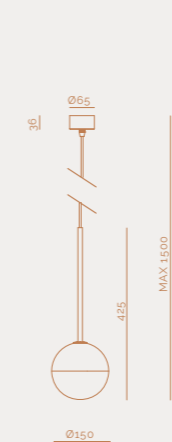

275.06.NNR

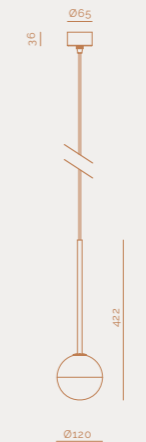

275.0.NNR

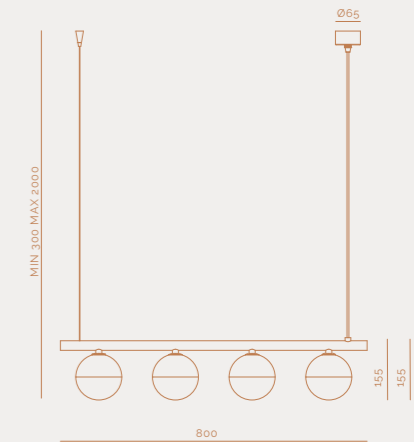

275.12.NNR

new product

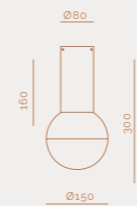

275.02.NNR



275.01.NNR



275.10.NNR

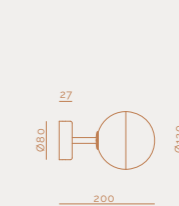

275.03.NNR

ALCHIMIA

Brogliato
Traverso

FINITURE / FINISHES

 vetro ramato
coppery glass
R
new

 ottone naturale
natural brass
ON



Alchimia — 277.05.ONR

NEW FINISHES

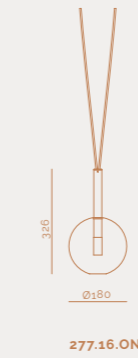
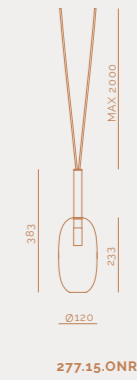
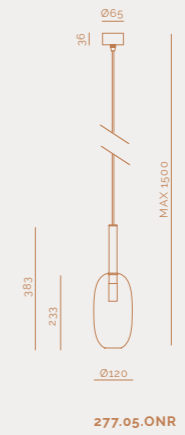
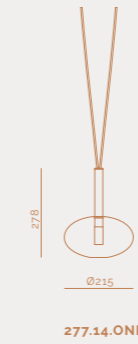
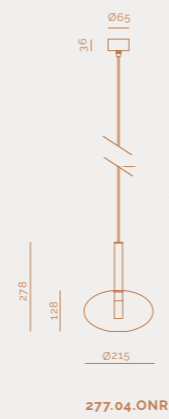
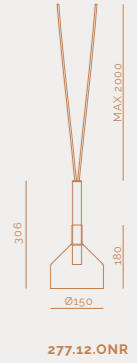
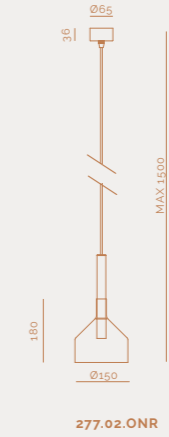
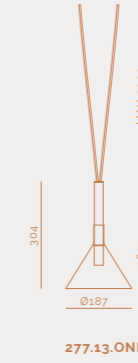
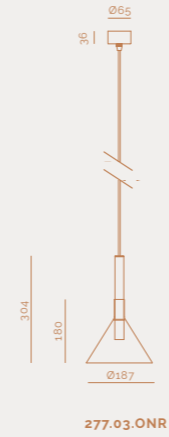

GRAPHIC DESIGN

/àr o/ studio

ART DIRECTION

/àr o/ studio

Studio Salaris

PHOTOGRAPHY

Beppe Brancato

Andrea Pancino

MADE AND PRINTED

Grafiche Antiga

Italy, April 2019

IL FANALE GROUP SRL

Via Bredariol 15

San Biagio di Callalta (TV)

31048 - Italy

Tel. +39 0422895200

Fax. +39 0422895110

info@ilfanale.com

www.ilfanale.com

